



TAPER-LOK[®] AND COFFERLOK[™] CONNECTION SYSTEMS

Engineered to Last... Leak-Free Service

Taper-Lok® and CofferLok™ Connection Systems

Our process piping, pipeline, riser and exchanger connection systems provide the solutions to chronic problems associated with standard ANSI and API flange connections.



Leak-Free Reliability

AFGlobal's metal-to-metal seal ring technology offers leak-free reliability over traditional ANSI and API gaskets. Our seal rings offer welded joint integrity and can be used in critical and chronic leak areas.



Weight Savings

With weight savings of up to 80% in comparison to ANSI flanges, our connection systems can typically save up to 1 million lbs. of weight on an offshore floating platform.



Space Savings

Space savings of up to 82% with smaller O.D. and length dimensions compared to ANSI/API flanges. Pipe runs are closer together for more room for process equipment and future tie-backs. Ideal for small O.D. pull-in-head requirements.



External Loads

Our connectors are able to handle high fatigue and high bending moments. We can optimize the design of the connector as needed to meet project requirements.



Quick Assembly

Our connection systems typically use less and smaller bolts in comparison to ANSI or API flanges. Our catalog of connectors include clamps that only require four bolts and connectors that are self aligning.



Cost Savings

In many cases, our connector assemblies are less expensive to purchase than the corresponding ANSI or API flange assembly. Our leak-free seal rings save operational costs.

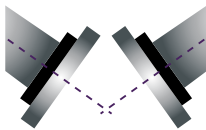

Misalignment Capability

AFGlobal offers connection systems that are self-aligning and offer up to 20° of misalignment capability.



High Pressure/Temperature

Our connector systems have applications in high pressure and/or high temperature where they out perform ANSI and API flanges in terms of reliability and leak free service.

Connector Applications



TOPSIDES

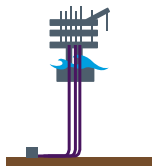

RISERS

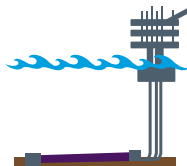

SUBSEA



REFINERY &
PETROCHEMICAL

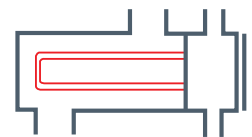

HEAT EXCHANGER
RETROFITS



		ANSI / API Flanges	CofferLok Compact Flange (Economy)	CofferLok Compact Flange (NORSOK L-005)	CofferLok Compact Flange (Standard)	CofferLok Clamp Connector	Taper-Lok
Leak-Free Reliability							
Weight Savings							
Space Savings							
External Loads							
Quick Assembly							
Cost Savings							
Misalignment Capability							
High Pressure/Temperature							

ICON RANK = 1 6
OK Superior

Taper-Lok® and CoffeLok™ Connection Systems

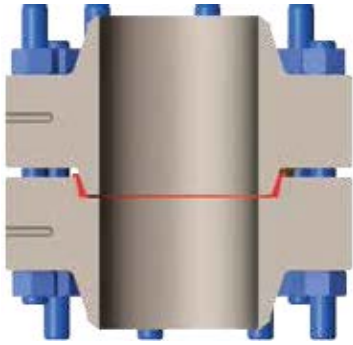

Taper-Lok Compact Flanges

Taper-Lok connections are industry-leading engineered connection systems. From the simple to the most extreme environments, *Taper-Lok* connections have provided over 40-years of leak free operation in a wide range of industries including offshore/onshore oil and gas, refining, chemical and cryogenic services. Self-aligning connector with misalignment capabilities.

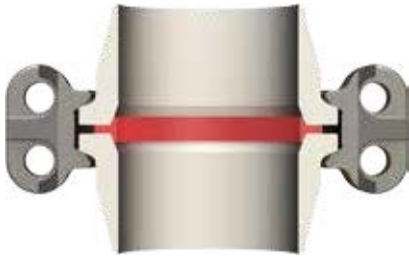

CoffeLok Clamp Connectors

The *CoffeLok* Clamp Connector is designed to offer the sealing technology and versatility of a mechanical joint. This connector serves the same purpose as a bolted flange assembly, with the advantages of being more easily installed (only 4 bolts) and up to 75% lighter and smaller by comparison to ANSI or API flanges.

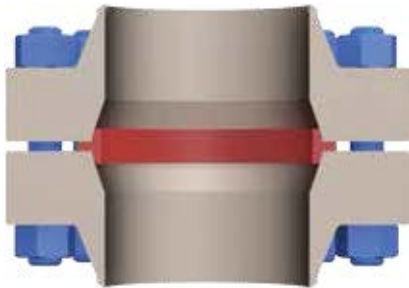

CoffeLok Compact Flanges (Standard)

The *CoffeLok* Compact Flange (standard) is a popular and more reliable alternative to ANSI/API flanges. It uses the same metal seal design found in the clamp connector, but is ideal for those that prefer a bolted flange design in a smaller and lighter joint over ANSI/API.

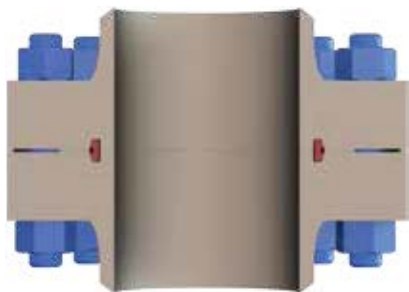

CoffeLok Compact Flanges (NORSOK L-005)

The *CoffeLok* Compact Flange (NORSOK L-005) has two independent metal-to-metal seals and offers an exceptionally strong mechanical connection. Considered a 'leak-free' connection, it also saves up to 82% weight and space as compared to ANSI or API flanges.

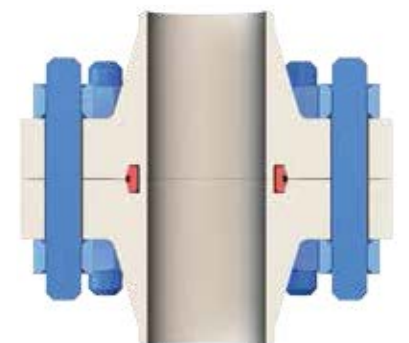

CoffeLok Compact Flanges (Economy)

The *CoffeLok* Compact Flange Economy combines the bulk manufacturing power of *Coffe* flanges with the *CoffeLok* "E" seal ring for an economic version of a compact flange. The *CoffeLok* "E" seal ring is a metal-to-metal seal that is able to solve chronic leak problems normally associated with ANSI flanges that are in critical services with high temperature and/or high pressure.

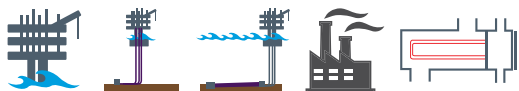

Taper-Lok® Connectors

- Over 40 years and thousands of connections with leak-free service
- Consists of a male and female flange that aids with misalignment
- Reusable metal-to-metal wide area seal with converging angles
- Sizes ½-in. – 85-in.*
- Pressures from vacuum to 20,000 psi*
- Services of -350°F to 1500°F*
- Field repairable
- Designed to withstand high external loads
- Visual seal aids with make-up
- Available in all material grades
- *Taper-Lok* connectors are subsea diver-friendly with additional features that provide ease of assembly and diver safety during the installation process

The benefits significantly decrease installation time and cost.

*Special designs available.

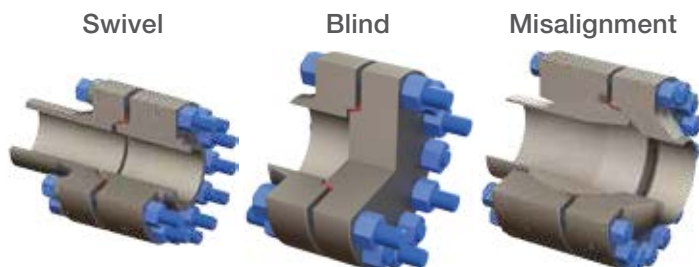
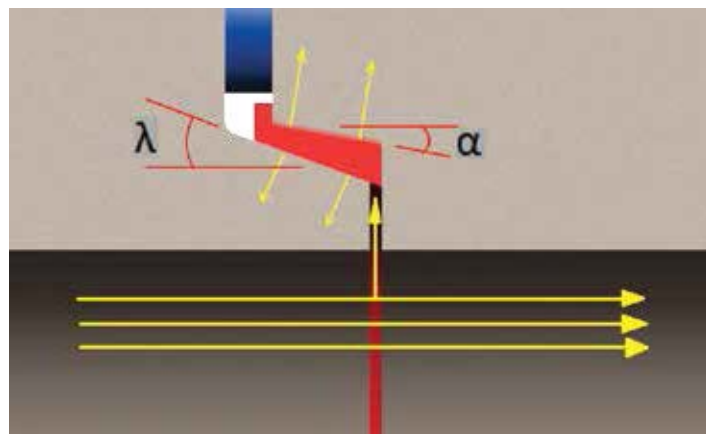

Applications

- Topsides, risers and subsea
- Petrochemical and refinery
- Spool tie-ins, production risers, manifolds and flow lines
- Pipeline transmission and distribution
- Heat exchanger body and channel flanges

8-in. – 2500# ANSI Class Comparison



Taper-Lok
Connector
246 kg

ANSI B16.5
628 kg





CofferLok™ Clamp Connectors

- Consists of (2) hubs, (1) seal ring, (1) clamp set with (4) bolts and (8) nuts
- Self energized, pressure enhanced metal seal ring
- Seal ring is designed to be reusable
- Clamp assembly is up to 75% lighter and requires less space compared to standard flanges
- Sizes from ½-in. to 36-in.*
- Pressures up to 20,000 psi*
- Available in all material grades
- The *CofferLok* Clamp Connector is interchangeable with other clamp connectors in the market

*Special designs available.

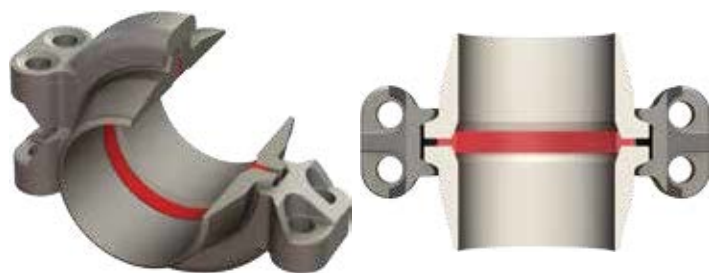
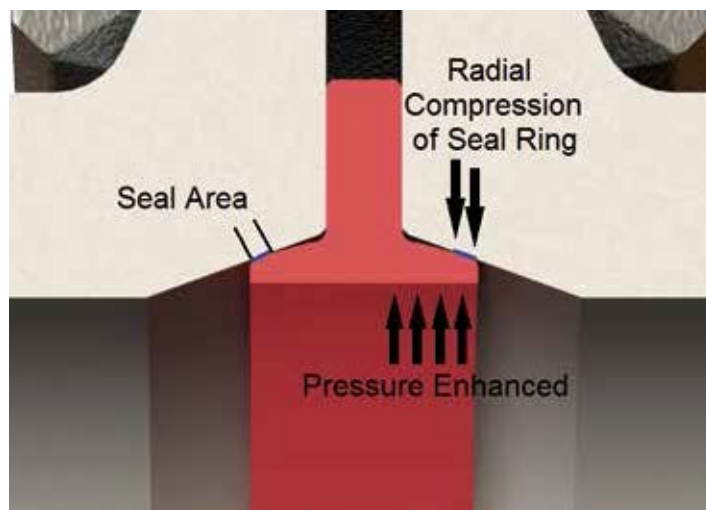

1500# Class Comparison

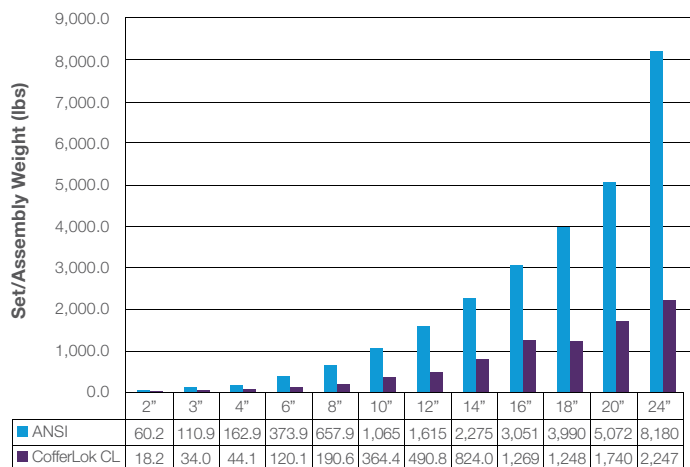

2500# Class Comparison

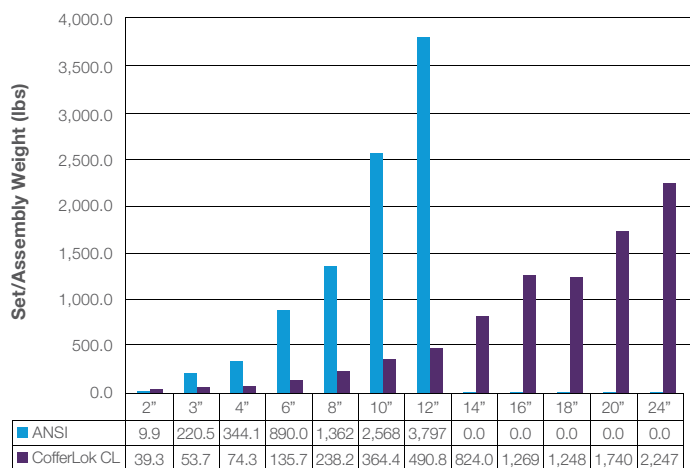

8-in. – 2500# ANSI Class Comparison



CofferLok Clamp Connector
-238 lbs

ANSI B16.5
-1,362 lbs.



CofferLok™ Compact Flanges (Standard)

- The *CofferLok* Compact Flange (standard) is lighter, smaller and easier to install than an ANSI raised face or ring joint flanges
- The *CofferLok* Compact Flange (standard) is available in all sizes/pressure classes and designed to offer improved sealing integrity while saving weight, space and cost
- Design codes under ANSI/ASME, API, BS 5500 and can meet customer’s specific requirements
- Achieves extremely high levels of performance by incorporating the three most important concepts in piping connector design
 1. Seal at the smallest possible diameter (to reduce separation loads)
 2. Use the *CofferLok* pressure enhanced metal seal (to reduce make-up load requirements)
 3. Isolates the seal from piping loads (to maintain performance under changing conditions)

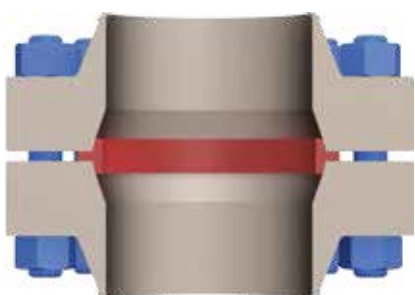
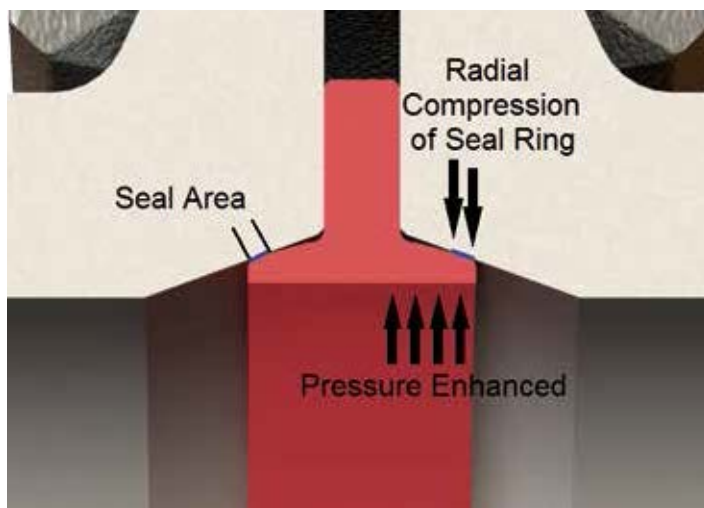

8-in. – 2500# ANSI Class Comparison



1500# Class Comparison

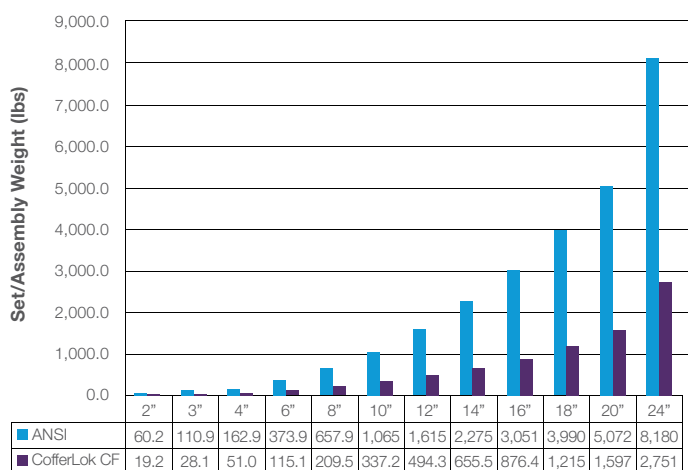

2500# Class Comparison

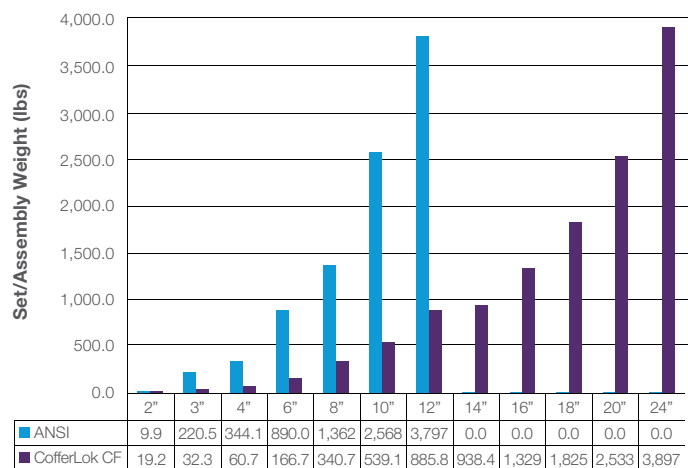



CofferLok™ Compact Flanges (NORSOK L-005)

- The *CofferLok* Compact Flange (NORSOK L-005) offers outstanding benefits whenever size, weight and stress are critical factors in pipe-design.
- Compared to ANSI Flange connections, *CofferLok* Compact Flanges (NORSOK L-005) save up to 82% of weight withstanding high bending and tension loads without leaking
- No retightening of bolts required
- Two independent metal sealing surfaces and static connection strength
- Design codes ASME VIII Div.2 Appendix 4 and 6, ANSI/ASME B31.3, B31.8, BS 500 and API
- The NORSOK L-005 standard covers up to 2500# class. 5K, 10K and 15K psi pressures available
- *CofferLok* “E” seal ring is interchangeable with NORSOK IX seal ring
- NORSOK L-005 is also known as ISO 27509

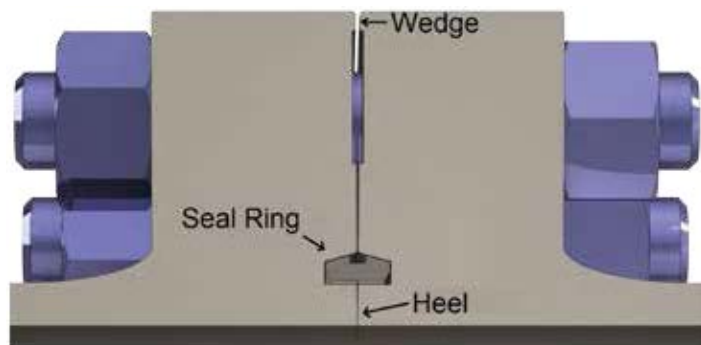

BEFORE ASSEMBLY

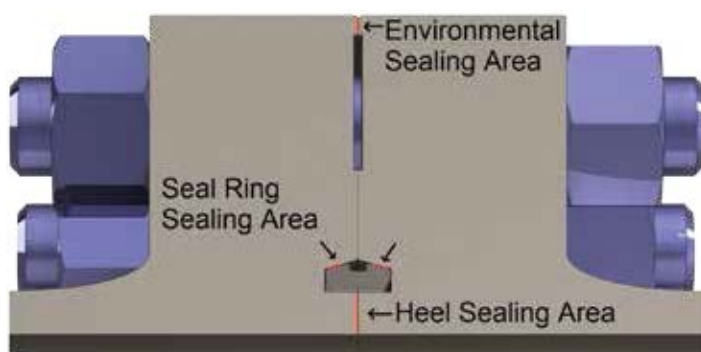

COMPLETED ASSEMBLY



CofferLok “E” Seal Ring

8-in. – 2500# ANSI Class Comparison

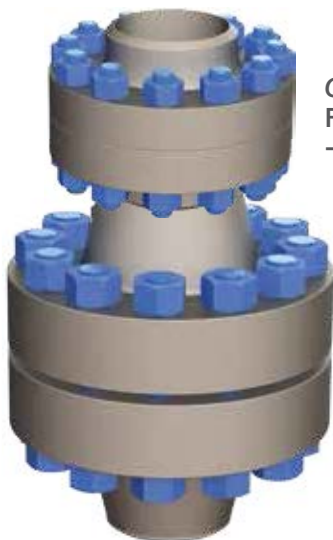

CofferLok Compact Flange (NORSOK)
-340 lbs

ANSI B16.5
-1,362 lbs.

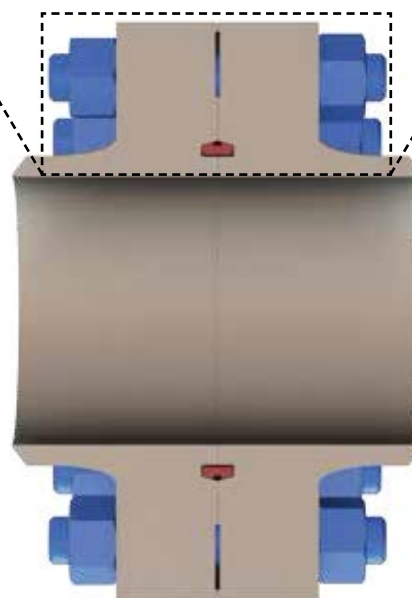

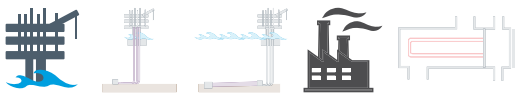

CofferLok™ Compact Flanges (Economy)

- The *CofferLok* Compact Flange (Economy) combines the bulk manufacturing power of Coffer flanges with the *CofferLok* “E” seal ring for an economic version of a compact flange.
- The *CofferLok* “E” seal ring is a metal-to-metal seal that is able to solve chronic leak problems normally associated with ANSI flanges that are in critical services with high temperature and/or high pressure.
- AFGlobal can modify your existing flange that is a leak problem in the field on your next shut down and give you peace of mind that your leak problems are solved.
- The “E” seal is a radially compressed, interference fit, self-energized and pressure enhanced seal that is designed to be reusable.

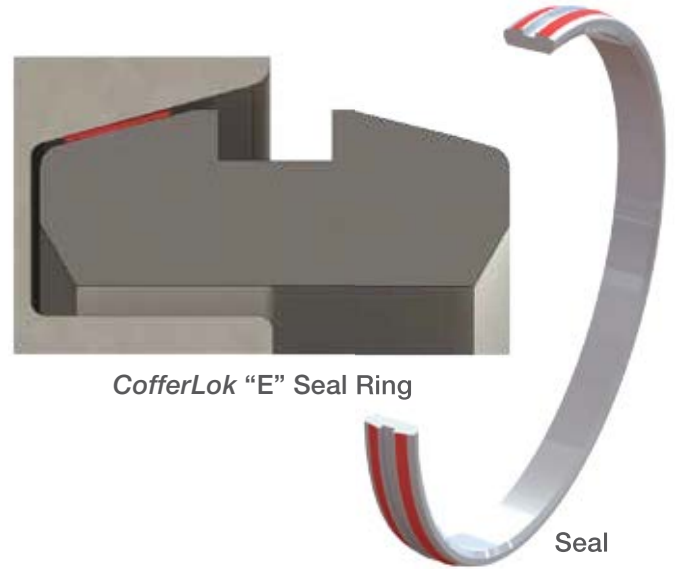

Less Cost + Less Size + More Reliable

=

CofferLok Compact Flange (Economy)

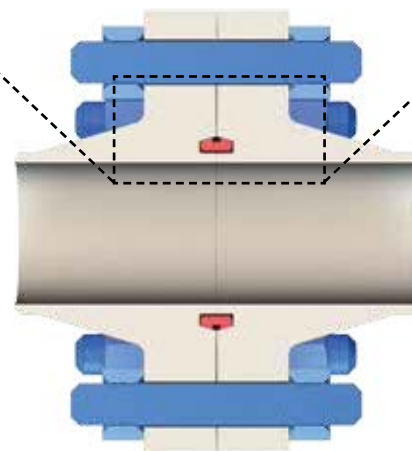
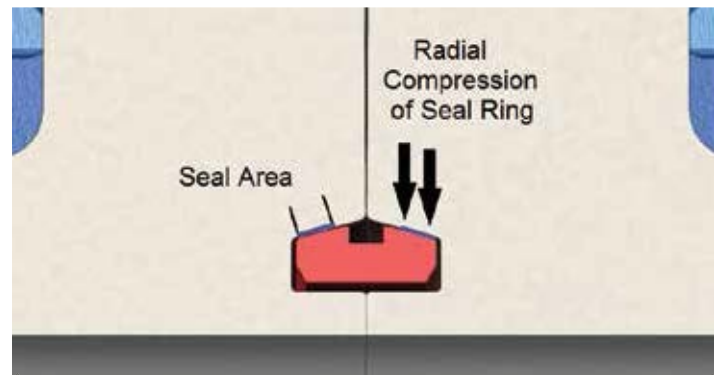

2-in. – 1500# ANSI Class Comparison



CofferLok
Economy
14 lbs.

ANSI
Flange
60 lbs.



Taper-Lok® Heat Exchanger Closure Retrofits

Problem

Cracking at the diaphragm weld is a common problem that causes extended down time and high repair costs.

Solution

Eliminate all problematic welding and simplify the design by using the *Taper-Lok* seal. The basic converging angle seal geometry wedges itself between the cover plate and channel wall to create a pressure tight seal. When internal pressure is applied, the seal becomes pressure enhanced, therefore creating a tighter seal and leak free service.

Benefits

- 5 to 1 cost reductions over equipment life
- Proven 3 step retrofit process
- Maintenance time reduced from 11 to 3 shifts
- Plant uptime increased

Elimination of:

- Seal weld and gouging of diaphragm
- Machining and stress relief of weld build up
- Nitrogen purge - hydrogen bake out
- Non-destructive weld testing to search for cracking
- Repeat of process when leaks detected
- Root causes of the problem

New Design with *Taper-Lok* Pressure Seal (No Diaphragm)



Machine *Taper-Lok* female seal groove into existing exchanger channel



Install *Taper-Lok* Seal Ring

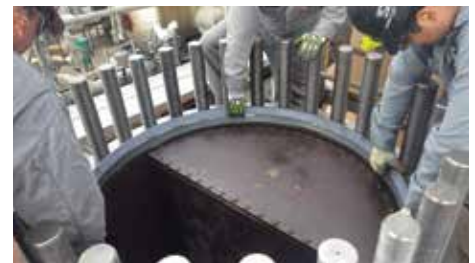

Install *Taper-Lok* male blind cover flange





Tensioning the connection

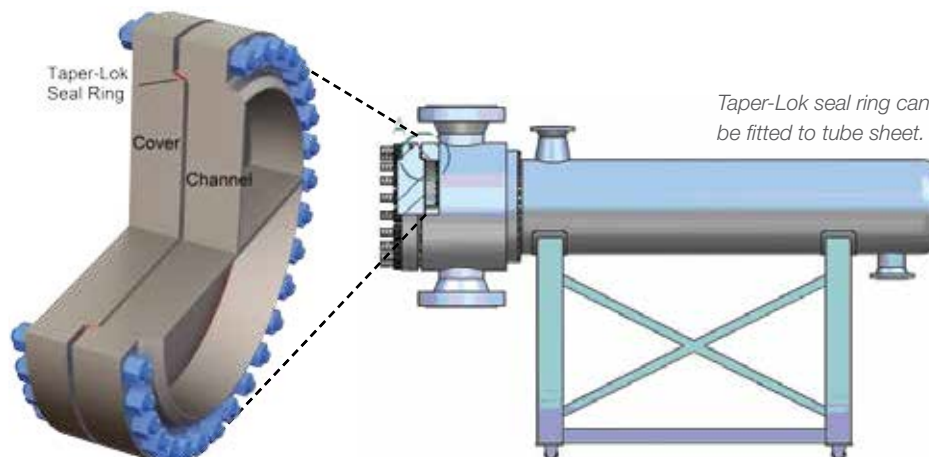

Taper-Lok Retrofit Complete



ANSI Flanges

ANSI Flanges		ANSI Specialty Flanges	
			
Diameter	½-in. to 200-in.	Diameter	½-in. to 200-in.
Pressure Class	150 psi to 2,500 psi	Pressure Class	150 psi to 2,500 psi
Faces	Multiple facing configurations with other combinations of diameter and pressure class available up to 200-in. OD	Faces	Multiple facing configurations with other combinations of diameter and pressure class available up to 200-in. OD
Materials Grades	Stainless, Nickel Alloys, Carbon and Alloy, Precipitation Hardening	Materials Grades	Stainless, Nickel Alloys, Carbon and Alloy, Precipitation Hardening

AFGlobal Brands: Ameriforge • Coffey • FVC

Global Locations





945 Bunker Hill, Suite 500 | Houston, Texas 77024 USA | 713-393-4200

afglobalcorp.com